



VA40 - VA45 Technical Datasheet

Variable area flowmeter

- Local indicator without auxiliary power
- Optionally available with limit switches or electrical signal output
- Visual product check (e. g. free from bubbles, colour)



1	Product features	3
1.1	Variable area flowmeters VA40 & VA45	3
1.2	Options and variants	4
1.3	Functional principle	6
2	Technical data	7
2.1	Technical data	7
2.2	Dimensions and weights	12
2.3	Measuring ranges	14
3	Installation	17
3.1	Intended use	17
3.2	Installation conditions	18
4	Electrical connections	19
4.1	Limit switch VA40	19
4.1.1	Connection of ring-type limit switch	20
4.1.2	Connection of limit switch MS14	20
4.1.3	Connection of limit switch TG21	21
4.2	Minimum clearance between two ring-type limit switches	21
4.3	4...20 mA linear position sensor WIM 200 / WIM 160	22
5	Order form	23

1.1 Variable area flowmeters VA40 & VA45

The variable area flowmeter VA40 is suitable for measuring liquids and gases from 1 to several thousand litres per hour. It is used to indicate and monitor flow rates in all types of basic applications up to max. 10 barg / 145 psig operating pressure and +100°C / +212°F product temperature.

The variable area flowmeter VA45 is suitable for measuring gases at low operating pressures of max. 1 barg / 14.5 psig.



① VA45
② VA40

Highlights

- Simple flow indication without power supply
- Visual product check (e. g. free from bubbles, colour)
- Can be used for liquids and gases
- Flow control with MIN/MAX limit monitoring
- Analogue measuring signal for recording and control purposes
- ATEX approval for hazardous areas

Industries

Can be used in all industrial sectors

Applications:

- Gas measurement for industrial furnaces
- Gas measurement for thermal process plants
- Gas measurement during inertisation
- Protective gas measurement
- Cooling and heating circuits
- Rinse processes

Other basic applications in plant and mechanical engineering as well as in the process industry.

1.2 Options and variants

Connection variants



- ① Connection V - screw connection
- ② Connection S - tube socket
- ③ Connection F - Flange version
- ④ Connection A - Aseptic

Ring-type limit switch



Ring-type limit switches are used for DN15 devices for small measuring glasses. The NAMUR ring-type switches are available with monostable or bistable characteristics.

Measuring range water: 0.16 to max. 25 l/h
 Measuring range air: 6 to max. 800 l/h

Limit switch MS14



The MS14 limit switch is used for all nominal sizes. When using this limit switch, the float is fitted with a magnet that triggers the switching operation. The integrated Reed contact operates potential-free. The switching operation is bistable.

Measuring range water: 1.3 to max. 10000 l/h
 Measuring range air: 50 to max. 310000 l/h

Limit switch TG21



The TG21 limit switch is used for nominal sizes DN25 to DN50. When using this limit switch, the float is fitted with a magnet that triggers the switching operation. The limit switch operates with a 2-wire NAMUR proximity switch. The switching operation is bistable.

Measuring range water: 23 to max. 10000 l/h
Measuring range air: 700 to max. 310000 l/h

Linear position sensor WIM 160 /WIM 200 with electrical output signal



The linear position sensors WIM 160 / WIM 200 are used for nominal sizes of DN25 to DN50. The float is fitted with a magnet so that the linear position sensor detects the position of the float and emits it as a 4...20 mA signal. A calibration curve enables the correlation between 4...20 mA values and flow values.

Measuring range water: 23 to max. 10000 l/h
Measuring range air: 700 to max. 310000 l/h

1.3 Functional principle

The flowmeter operates in accordance with the float measuring principle.

The measuring unit consists of a glass cone in which a float can move freely up and down.

The medium flows through the flowmeter from bottom to top.

The float adjusts itself so that the buoyancy force F_1 acting on it, the form resistance F_2 and its weight F_3 are in equilibrium: $F_3 = F_1 + F_2$

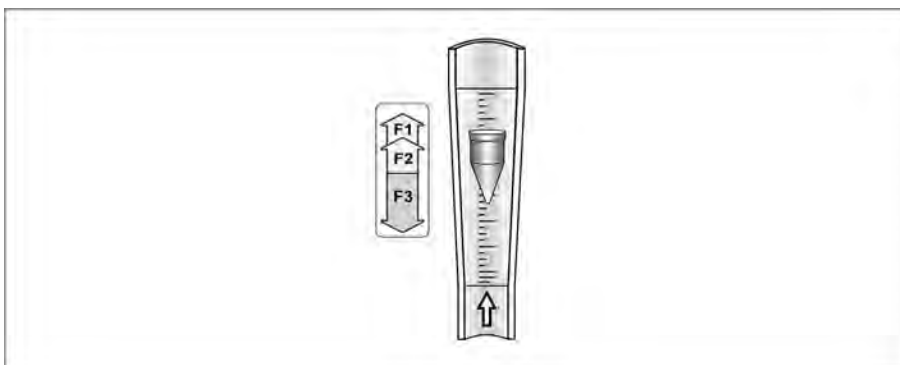

The height of the float is read on the scale of the measuring glass and indicates the flow rate.

The top edge of the float of the VA40 marks the reading line for flow values.

For the top edge of the float of the VA45 refer to "Measuring ranges VA45".

2.1 Technical data

- *The following data is provided for general applications. If you require data that is more relevant to your specific application, please contact us or your local sales office.*
- *Additional information (certificates, special tools, software,...) and complete product documentation can be downloaded free of charge from the website (Downloadcenter).*

Measuring system

Application range of VA40	Flow measurement of liquids and gases
Application range of VA45	Flow measurement of gases
Function / Measuring principle	Variable area measuring principle
Measured value	
Primary measured value	Float position
Secondary measured value	Operating volume flow and nominal volume flow
Measurement accuracy	
Directive	VDI/VDE 3513, sheet 2 ($q_G = 50\%$)
VA40	1.0%
VA45	2.5%

Operating conditions

Temperature	
Max. operating temperature TS	-20...+100°C / -4...+212°F
Pressure	
Device version	Max. permitted operating gauge pressure PS at TS = +100°C / +212°F
VA40 - DN15, DN25	10 barg / 145 psig ①
VA40 - DN40	9 barg / 131 psig ①
VA40 - DN50	7 barg / 102 psig ①
VA45	1 barg / 14.5 psig ①
Max. test pressure PT	Pressure equipment directive (refer to nameplate)

Installation conditions

Inlet section	$\geq 5 \times \text{DN}$
Outlet run	$\geq 3 \times \text{DN}$

① Other pressures on request

Materials

Screw connection VA.../R	Stainless steel 1.4404 (316 L)
Screw connection VA.../ST	Steel, electroplated and chromised
Tube socket	Stainless steel 1.4404 (316 L)
Flange connection VA.../R	Stainless steel 1.4404 (316 L)
Screw connection / tube socket VA.../PV	PVDF
Housing	Stainless steel 1.4301 (304) electro-polished
Union nut	Aluminium / powder coated Option: stainless steel
Measuring cone	Borosilicate glass
Float VA45	Aluminium
Float VA40	Stainless steel 1.4571 (316 Ti), Hastelloy®, TFM (PTFE), aluminium, Polypropylene (PP)
Float stop and insert	PVDF (FDA conform)
Gaskets	NBR, EPDM (FDA conform), FFKM, FPM

Temperatures

For devices to be used in hazardous areas, special temperature ranges apply. These can be found in the Ex supplementary instructions.

Max. product temperature T_m	-20...+100°C ①	-4...+212°F ①
Max. ambient temperature T_{amb}	-20...+100°C	-4...+212°F

① higher temperatures on request

Limit switches

(only VA40)

Type	Switching function	Connection	Shape	Note
I7R2010-N RC10-14-N0	monostable	2-wire NAMUR	Ring-type limit switch	non Ex
I7R2010-NL RC10-14-N3	bistable	2-wire NAMUR	Ring-type limit switch	non Ex
I7R2015-N RC15-14-N0	monostable	2-wire NAMUR	Ring-type limit switch	non Ex
I7R2015-NL RC15-14-N3	bistable	2-wire NAMUR	Ring-type limit switch	non Ex
RB15-14-E2	bistable	3-wire transistor	Ring-type limit switch	non Ex
MS 14/A	bistable	2-wire, potential-free	Reed contact	Float with magnet required
TG 21	bistable	2-wire NAMUR	Proximity switch	Float with magnet required

Use of limit switches

Size	Cone no.	Limit switches	Size	Cone no.	Limit switches	
DN15	G 13.11	-	DN25	N 21.09	MS14/A	TG21
	G 14.06	-		N 21.13	MS14/A	TG21
	G 14.08	-		N 21.18	MS14/A	TG21
	G 15.07	Ring Ø 10 mm		N 21.25	MS14/A	TG21
	G 15.09	Ring Ø 10 mm	DN40	N 41.09	MS14/A	TG21
	G 15.12	Ring Ø 10 mm		N 41.13	MS14/A	TG21
	G 16.08	Ring Ø 10 mm		N 41.19	MS14/A	TG21
	G 16.12	Ring Ø 10 mm	DN50	N 51.10	MS14/A	TG21
	G 17.08	Ring Ø 10 mm		N 51.15	MS14/A	TG21
	G 17.12	Ring Ø 15 mm		N 51.21	MS14/A	TG21
	N 18.07	MS14/A				
	N 18.09	MS14/A				
	N 18.13	MS14/A				
	N 19.09	MS14/A				
	N 19.13	MS14/A				
	N 19.19	MS14/A				
	N 19.26	MS14/A				

Technical data of limit switches

Limit switches	I7R2010-NL	I7R2015-NL	I7R2010-N	I7R2015-N	RB15-14-E2
	RC10-14-N3	RC15-14-N3	RC10-14-N0	RC15-14-N0	
Ring diameter	10 mm / 0.4"	15 mm / 0.6"	10 mm / 0.4"	15 mm / 0.6"	15 mm / 0.6"
Switching function	bistable	bistable	monostable	monostable	bistable
NAMUR	yes	yes	yes	yes	no
Connection technology	2-wire	2-wire	2-wire	2-wire	3-wire
Nominal voltage U_0	8 VDC	8 VDC	8 VDC	8 VDC	-
Current consumption	≤ 1 mA passage \downarrow		≥ 3 mA - ball outside limit switch		-
Current consumption	≥ 3 mA passage \uparrow		≤ 1 mA - ball in the limit switch		-
Operating voltage $U_{ext.}$					10...30 VDC
Operating current					0...100 mA
No load current					20 mA
Output U_a - passage \downarrow					≤ 1 V
Output U_a - passage \uparrow					$\geq U_b$ - 3 VDC

Technical data of MS14

Contact type	Normally open or normally closed, can be reconnected
Switching repeatability	< 2% of full scale range
Switching capacity	12 VA
Max. turn-on voltage	30 VDC
Max. switching current	0.5 A
Ambient temperature	-40...+85°C / -40...+185°F
Ingress protection acc. to EN 60529 / IEC 529	IP65

Technical data of TG21

Rated voltage	8 VDC
Current consumption, active surface open	3 mA
Current consumption, active surface covered	1 mA
Ambient temperature	-25...+100°C / -13...+212°F
Ingress protection acc. to EN 60529 / IEC 529	IP67 (NEMA 6)

Technical data of linear position sensor WIM 200 / WIM 160

Device size	Sensor type
VA40 DN15	Not applicable
VA40 DN25	WIM 200
VA40 DN40	WIM 200
VA40 DN50	WIM 160
Electrical data	
Operating voltage U	14...30 VDC
Connection	brown (+), blue (-)
Output function	2-wire, current output
Current output WIM 160	4...20 mA = 0...160 mm / 0...6.3"
Current output WIM 200	4...20 mA = 0...200 mm / 0...7.9"
Load impedance	$\leq [(U-14V)/20mA]$ k Ω
Cable length of connection	2 m / 6.6 ft
Cable quality	4 mm / 0.16", blue, PVC
Cable cross-section	2 x 0.25 mm ² (blue/brown)
Accuracy	
Uncertainty of current output dep. on flow	2.5% acc. to VDI/VDE 3513-2 (q _Q = 50%)
Temperature influence	$\leq \pm 0.06$ %/K
Ambient	
Ambient temperature	-25...+65°C / -13...+149°F
Housing material	Aluminium, coated
Housing protection class	IP67

2.2 Dimensions and weights

Dimensions of VA40

EN	ASME	Type					
		a	b	Type V c	Type S c	Type F c	Type A c
Dimensions [mm]							
DN15	1/2"	239	26	375	400	425 ①	375
DN25	1"	239	36	375	450	425 ①	375
DN40	1 1/2"	235	46	375	450	425 ①	375
DN50	2"	227	62	375	450	425 ①	375
Dimensions ["]							
DN15	1/2"	9.41	1.02	14.8	15.8	16.7 ②	14.8
DN25	1"	9.41	1.42	14.8	17.7	16.7 ②	14.8
DN40	1 1/2"	9.26	1.81	14.8	17.7	16.7 ②	14.8
DN50	2"	8.94	2.44	14.8	17.7	16.7 ②	14.8

① Option 500 mm

② Option 19.7"

VA40/V

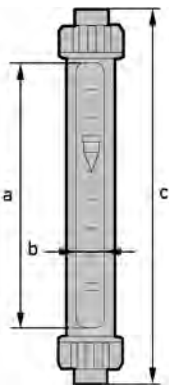

VA40/S

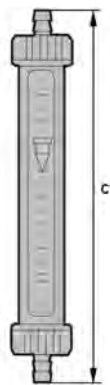

VA40/F

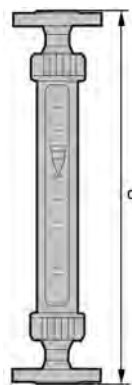

VA40/A

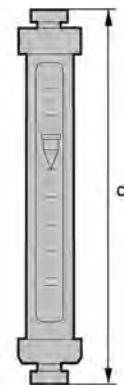

Dimensions of VA45

		a		b		c (Type V)		c (Type S)		c (Type F)	
EN	ASME	[mm]	["]	[mm]	["]	[mm]	["]	[mm]	["]	[mm]	["]
DN15	1/2"	118	4.65	26	1.02	254	10.0	279	11.0	304	12.0
DN25	1"	118	4.65	36	1.42	254	10.0	329	13.0	304	12.0
DN40	1 1/2"	114	4.49	46	1.81	254	10.0	329	13.0	304	12.0

VA45/V

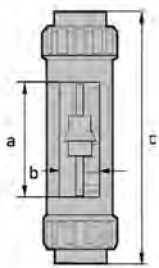

VA45/S

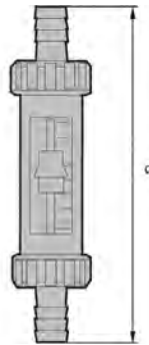

VA45/F

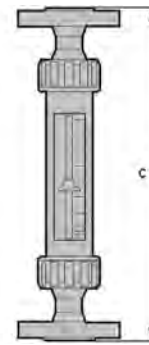

Weights

Nominal size	VA40 type V, S, A		VA40 type F		VA45 type V, S		VA45 type F	
	kg]	[lb]	kg]	[lb]	kg]	[lb]	kg]	[lb]
DN15	0.5	1.1	1.8	4.0	0.4	0.88	1.7	3.7
DN25	1.3	2.9	3.8	8.4	1.2	2.6	3.7	8.2
DN40	2.3	5.1	6.8	15.0	2.2	4.9	6.7	14.8
DN50	3.6	7.9	9.2	20.3	-	-	-	-

Process connection

		Type V		Type S	Type F		Type A	
		Female thread acc. to			Flanges acc. to		Pipe	Clamp
EN	ASME	ISO 228	ASME B1.20	Ø [mm]	EN 1092-1	ASME B16.5	DIN 11851	ISO 2852
DN15	1/2"	G3/8...1/2	1/2 NPT	15	DN15	1/2"	SC15 ①	17.2 ①
DN25	1"	G3/4...G1	1 NPT	28	DN25	1"	SC25 ①	25 ①
DN40	1 1/2"	G1 1/2	1 1/2 NPT	42	DN40	1 1/2"	SC40 ①	40 ①
DN50 ①	2" ①	G2 ①	2 NPT ①	52 ①	DN50 ①	2" ①	SC50 ①	51 ①

① only VA40

2.3 Measuring ranges

Measuring ranges VA40

Measuring span:	10 : 1		
Flow values:	Values = 100%	Water: +20°C / +68°F	Air: +20°C / +68°F, 1.013 bara / 14.7 psia
Float:	1 Stainless steel or Hastelloy® - 2 PTFE/TFM with insert - 3 PTFE/TFM - 4 Aluminium - 5 Polypropylene (PP)		

Materials →		1	2	3	1	3	4	5	1	2	3	4	5
Cone ↓		Water [l/h]			Air [Nm ³ /h]				Max. pressure loss [mbar]				
G 13.11 ①	DN15	0.4	-	-	0.016	-	0.007	-	2	-	-	1	-
G 14.06		0.63	-	-	0.025	-	0.012	-	3	-	-	2	-
G 14.08		1	-	-	0.04	-	0.02	-	4	-	-	3	-
G 15.07		1.6	-	-	0.06	-	0.03	-	4	-	-	3	-
G 15.09		2.5	-	-	0.09	-	0.04	-	5	-	-	4	-
G 15.12		4	-	-	0.14	-	0.06	-	6	-	-	5	-
G 16.08		6.3	-	-	0.2	-	0.1	-	6	-	-	5	-
G 16.12		10	-	-	0.3	-	0.16	-	7	-	-	6	-
G 17.08		16	-	-	0.5	-	0.25	-	7	-	-	6	-
G 17.12		25	-	-	0.8	-	0.4	-	8	-	-	7	-
N 18.07		40	25	13	1.5	0.6	0.8	0.5	9	6	2	3	1
N 18.09		63	40	22	2.2	0.95	1.2	0.7	9	7	3	3	2
N 18.13		100	63	35	3.5	1.5	2.0	1.2	9	8	3	4	2
N 19.09		160	100	55	5.2	2.2	2.8	1.8	13	9	4	5	2
N 19.13		250	160	85	8	3.3	4.5	2.8	16	11	4	5	2
N 19.19		400	250	140	-	-	-	-	21	14	5	-	-
N 19.26		630	400	230	-	-	-	-	27	17	6	-	-
N 21.09	DN25	630	400	230	18 ②	9	11	7	22	14	6	8	3
N 21.13		1000	630	350	28 ②	14	18	12	23	17	6	8	4
N 21.18		1600	1000	600	49 ②	-	28 ②	17 ②	26	25	7	10	6
N 21.25		2500	1600	950	70 ②	-	42 ②	26 ②	33	40	8	12	9
N 41.09	DN40	1600	1000	600	45 ②	22	28	18	32	18	9	11	5
N 41.13		2500	1600	900	70 ②	36	45 ②	28 ②	34	20	10	12	5
N 41.19		4000	2500	1500	128 ②	-	76 ②	46 ②	38	24	11	15	8
N 51.10	DN50	4000	2500	1500	120 ②	56	70	45	43	25	12	15	7
N 51.15		6300	4000	2400	190 ②	90	110 ②	70 ②	47	30	13	16	7
N 51.21		10000	6300	3500	310 ②	-	170 ②	118 ②	55	42	14	20	10

① Accuracy 2.5%

② only possible with guided float

The operating pressure should be at least double the pressure loss for liquids and five times for gases. The indicated pressure losses are valid for water and air at maximum flow rate. Other flow ranges on request. Conversion of other media or operating data is performed using the calculation method in accordance with VDI/VDE directive 3513.

Measuring ranges VA40

Measuring span:	10 : 1		
Flow values:	Values = 100%	Water: +20°C / +68°F	Air: +20°C / +68°F, 1.013 bara / 14.7 psia
Float:	1 Stainless steel or Hastelloy® - 2 PTFE/TFM with insert - 3 PTFE/TFM - 4 Aluminium - 5 Polypropylene (PP)		

Materials →		1	2	3	1	3	4	5	1	2	3	4	5
Cone ↓		Water [GPH]			Air [SCFM]				Max. pressure loss [psi]				
G 13.11 ①	DN15	0.11	-	-	0.01	-	0.004	-	0.03	-	-	0.02	-
G 14.06		0.17	-	-	0.015	-	0.007	-	0.04	-	-	0.03	-
G 14.08		0.26	-	-	0.025	-	0.012	-	0.06	-	-	0.04	-
G 15.07		0.42	-	-	0.037	-	0.018	-	0.06	-	-	0.04	-
G 15.09		0.66	-	-	0.056	-	0.025	-	0.07	-	-	0.06	-
G 15.12		1.06	-	-	0.087	-	0.037	-	0.09	-	-	0.07	-
G 16.08		1.66	-	-	0.12	-	0.062	-	0.09	-	-	0.07	-
G 16.12		2.64	-	-	0.19	-	0.09	-	0.1	-	-	0.09	-
G 17.08		4.23	-	-	0.31	-	0.16	-	0.1	-	-	0.09	-
G 17.12		6.60	-	-	0.5	-	0.25	-	0.1	-	-	0.1	-
N 18.07		10.6	6.6	3.43	0.93	0.37	0.5	0.31	0.1	0.1	0.03	0.04	0.02
N 18.09		16.6	10.6	5.81	1.36	0.59	0.74	0.43	0.1	0.1	0.04	0.04	0.03
N 18.13		26.4	16.6	9.25	2.17	0.93	1.24	0.74	0.1	0.1	0.04	0.06	0.03
N 19.09		42.3	26.4	14.5	3.2	1.36	1.7	1.1	0.19	0.13	0.06	0.07	0.03
N 19.13		66.0	42.3	22.5	4.96	2.05	2.8	1.7	0.2	0.16	0.06	0.07	0.03
N 19.19		105	66.0	37	-	-	-	-	0.3	0.2	0.07	-	-
N 19.26		166	106	60.8	-	-	-	-	0.4	0.25	0.09	-	-
N 21.09	DN25	166	106	60.8	11.2 ②	5.58	6.8	4.3	0.3	0.2	0.09	0.1	0.06
N 21.13		264	166	92.5	17.4 ②	8.68	11	7.4	0.3	0.25	0.09	0.1	0.06
N 21.18		423	264	158	30.4 ②	-	17 ②	10.5 ②	0.3	0.3	0.1	0.15	0.9
N 21.25		660	423	251	43.4 ②	-	26 ②	16 ②	0.48	0.58	0.1	0.17	0.13
N 41.09	DN40	423	264	158	27.9 ②	13.6	17	11	0.48	0.26	0.1	0.16	0.07
N 41.13		660	423	238	43.4 ②	22.3	28 ②	17.4 ②	0.49	0.29	0.15	0.17	0.07
N 41.19		1057	660	396	79.4 ②	-	47 ②	28.5 ②	0.55	0.35	0.16	0.22	0.1
N 51.10	DN50	1057	660	396	74.4 ②	34.7	43.4	27.9	0.62	0.36	0.17	0.22	0.1
N 51.15		1664	1057	634	118 ②	55.8	68 ②	43.4 ②	0.68	0.44	0.19	0.23	0.1
N 51.21		2642	1664	925	192 ②	-	105 ②	73 ②	0.8	0.61	0.2	0.29	0.15

① Accuracy 2.5%

② only possible with guided float

The operating pressure should be at least double the pressure loss for liquids and five times for gases. The indicated pressure losses are valid for water and air at maximum flow rate. Other flow ranges on request. Conversion of other media or operating data is performed using the calculation method in accordance with VDI/VDE directive 3513.

Measuring ranges VA45

Measuring span:	10 : 1	
Flow values:	Values = 100%	Air: +20°C / +68°F, 1.013 bara / 14.7 psia

Float shape and reading line

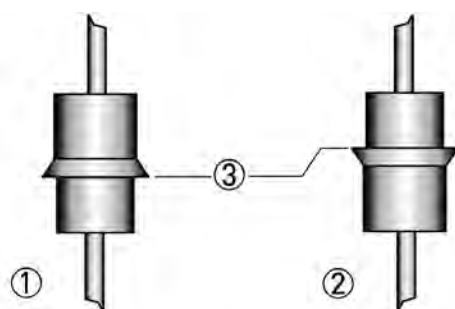

- ① Float shape C
- ② Float shape D
- ③ Reading line

	Cone no.	Shape	Flow, air		Pressure loss	
			[NI/h]	[SCFH]	[mbar]	[psi]
DN15	N 15.01	C	1500...2300	55.8...85.6	3	0.044
		D	2300...4800	85.6...179	3	0.044
	N 15.02	C	5500...9000	205...335	3	0.044
		D	9000...16000	335...595	3	0.044
DN25	N 25.01	C	3000...5000	112...186	3	0.044
		D	5000...7500	186...279	3	0.044
	N 25.02	C	7500...16500	279...614	3	0.044
		D	16500...25000	614...930	4	0.058
DN40	N 40.01	C	17000...26000	632...967	4	0.058
		D	26000...34000	967...1265	4	0.058
	N 40.02	C	34000...60000	1265...2232	4	0.058
		D	60000...75000	2232...2790	4	0.058

The operating pressure should be at least five times the pressure loss for gases. The indicated pressure losses are valid for air at maximum flow rate. Other flow ranges on request. Conversion of other media or operating data (pressure, temperature, density, viscosity) is performed using the calculation method in accordance with VDI/VDE directive 3513.

Reference condition for gas measurements:

Flow measurements for gases are attributed to

NI/h or Nm³/h: Volume flow at standard (norm.) conditions 0°C / +32°F, 1.013 bara / 14.7 psia (DIN 1343)

SCFM or SCFH: Volume flow at standard (std.) conditions +15°C / +59°F, 1.013 bara / 14.7 psia (ISO 13443)

3.1 Intended use

Responsibility for the use of the measuring devices with regard to suitability, intended use and corrosion resistance of the used materials against the measured fluid lies solely with the operator.

This device is a Group 1, Class A device as specified within CISPR11:2009. It is intended for use in industrial environment. There may be potential difficulties in ensuring electromagnetic compatibility in other environments, due to conducted as well as radiated disturbances.

The manufacturer is not liable for any damage resulting from improper use or use for other than the intended purpose.

The variable area flowmeter VA40 is suitable for measuring liquids and gases.

The variable area flowmeter VA45 is suitable for measuring gases at low operating pressures.

Intended use:

- The product may not contain any ferromagnetic particles or solids. It may be necessary to install magnetic filters or mechanical filters.
- The product must be sufficiently liquid and free of deposits.
- Avoid pressure surges and pulsing flows.
- Open valves slowly. Do not use solenoid valves.

Use suitable measures to eliminate compression vibrations during gas measurements:

- Short pipeline lengths to next restriction
- Nominal pipe size not greater than nominal device size
- Increase in operating pressure (while taking into account the resulting change in density and thus change in scale)

For devices used in hazardous areas, additional safety notes apply; please refer to the Ex documentation.

Do not use any abrasive or highly viscous media.

3.2 Installation conditions

When installing the device in the piping, the following points must be observed:

- *The variable area flowmeter must be installed vertically (measuring principle). Flow direction from bottom to top. For installation recommendations please refer also to directive VDI/VDE 3513, sheet 3.*
- *Before connecting, blow or flush out the pipes leading to the device.*
- *The piping for gas flow need to be dried before the device is installed.*
- *Use connectors suitable for the particular device version.*
- *Align the piping centrally with the connection bores on the measuring device so they are free of stresses.*
- *If necessary, the piping has to be supported to avoid the vibrations transmitted to the measuring device.*
- *Do not lay signal cables directly next to cables for the power supply.*

4.1 Limit switch VA40

The flowmeters VA40 can be equipped with a maximum of two limit switches.

Bistable function: Stable switching when passing through the switching point

Monostable function: Switching pulse at operating point

For use, selection and function refer to chapter "Technical data".

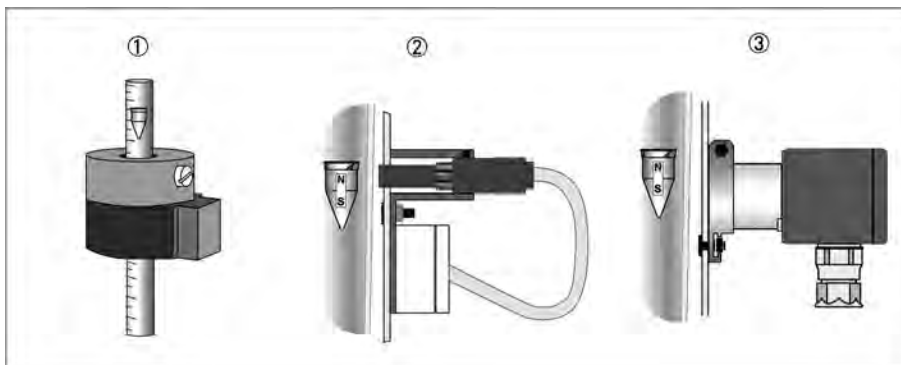

Figure 4-1: Types of limit switches

- ① Ring-type limit switch
- ② MS 14/I - potential-free Reed contact
- ③ TG21 - with integrated switching vane and proximity switch

4.1.1 Connection of ring-type limit switch

The two connecting cables of the limit switch are guided through the long slot on the back.

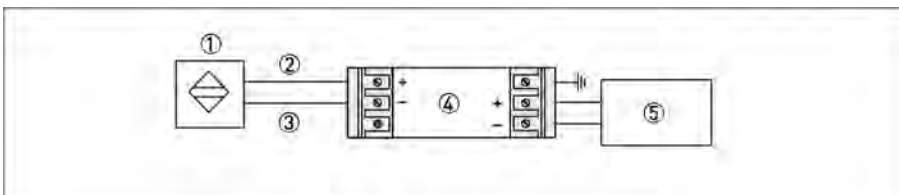

Figure 4-2: Connection of ring-type limit switch, 2-wire NAMUR

- ① Limit switch 2-wire NAMUR
- ② Connecting cable brown +
- ③ Connecting cable blue -
- ④ EMC filter
- ⑤ Receiver device

The bistable limit switches must be operated with an EMC filter.
The monostable limit switches do not require an EMC filter.

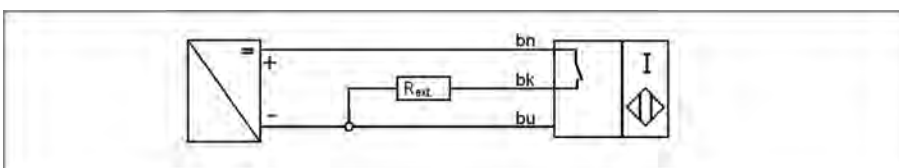

Figure 4-3: Connecting diagram of ring-type limit switch, 3-wire transistor

- bn - brown plus
- bk - black switch
- bu - blue minus

4.1.2 Connection of limit switch MS14

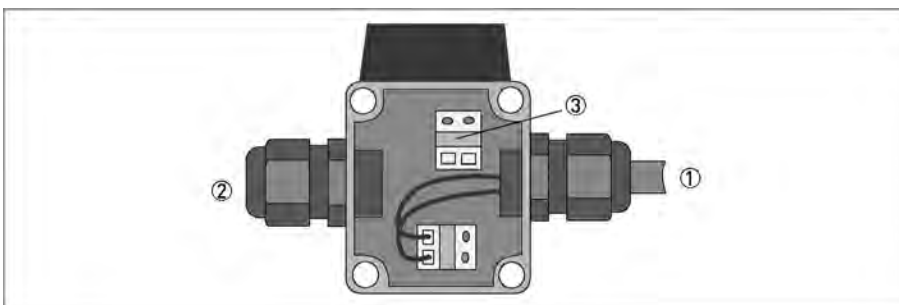

Figure 4-4: Connection limit switch type MS14

- ① Connection for Reed switch
- ② Connection for receiver device
- ③ Terminal connection (potential free)

The switching function requires a float with integrated magnet.

4.1.3 Connection of limit switch TG21

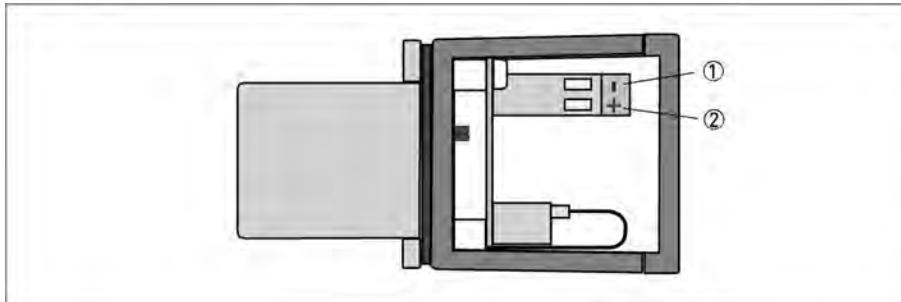

Figure 4-5: Connection limit switch type TG21

- ① Terminal -
- ② Terminal +

The TG21 is adapted for isolated switching amplifiers with an intrinsically safe circuit acc. to EN 60947-5-6 NAMUR.

The TG21 includes an inductive proximity switch with bistable switching characteristics. The proximity switch is activated by the immersion of an aluminium vane. The magnet of the switching vane is moved by the magnet in the float.

The switching function requires a float with integrated magnet.

4.2 Minimum clearance between two ring-type limit switches

Where two limit switches are used in one device are in close proximity of each other, minimum clearances must be maintained in order to avoid mutual influence of the switches.

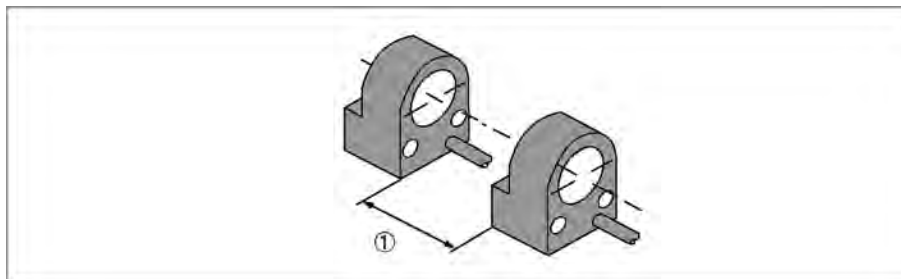

Minimum clearance	2-wire		3-wire	
	①	16 mm	0.63"	45 mm

4.3 4...20 mA linear position sensor WIM 200 / WIM 160

The flowmeter VA40 with nominal diameter DN25, DN40 and DN50 can be equipped with a linear position sensor, which outputs a 4...20 mA current output signal linearly to the position of the float. The flow values corresponding to the current values can be assigned using the calibration curve supplied.

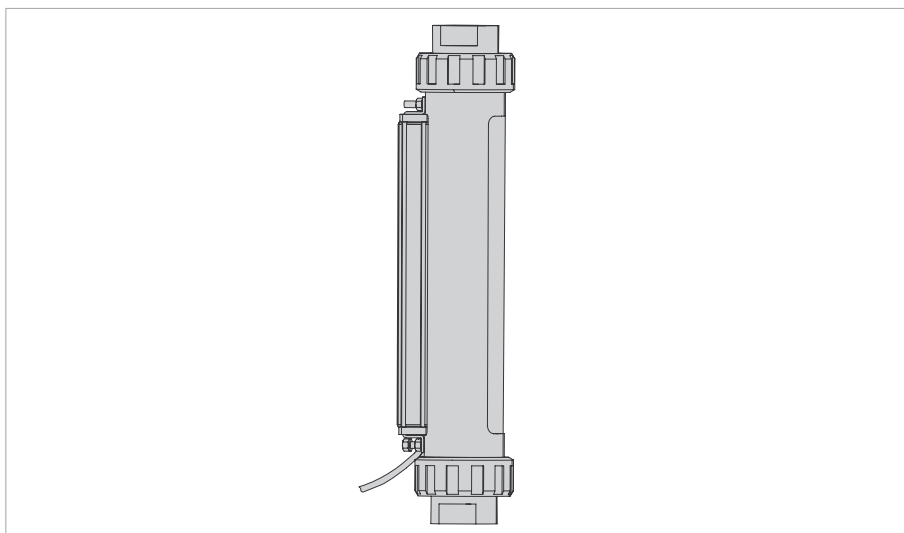

Figure 4-6: VA40 with linear position sensor WIM

Connecting the linear position sensors WIM 200 / WIM 160

The linear position sensors WIM 200 / WIM 160 are designed in 2-wire technology, i.e. the power supply as well as the 4...20 mA measuring signal are on the two identical connecting cables.

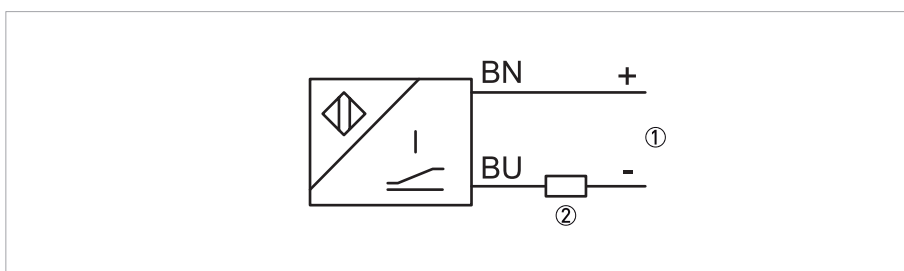

Figure 4-7: Connection diagram for linear position sensor WIM 200 / WIM 160

- ① Power supply 14...30 VDC, brown (+), blue (-)
- ② External load $< [(U-14V)/20mA] \text{ k}\Omega$

Further information, especially for use in hazardous areas and connection to certified Ex i circuits, can be found in the relevant supplementary instructions.

Please provide us with the missing information so that we can be of help to you as quickly as possible.

Then please fax this page to the appropriate sales associate. We will then contact you as soon as possible.

Device data

Connection type:	<input type="checkbox"/> V (Screw connection)	<input type="checkbox"/> S (Tube socket)	<input type="checkbox"/> F (Flange)	<input type="checkbox"/> A (Aseptic)
Pressure rating:				
Raised face:	<input type="checkbox"/> Flange:			
Limit switches:	<input type="checkbox"/> K1 ① <input type="checkbox"/> K2 ②			
Signal output:	<input type="checkbox"/> WIM (4...20 mA)			
Approval:	<input type="checkbox"/> None	<input type="checkbox"/> ATEX		

① 1 limit switch

② 2 limit switches

Design data

Medium:			
Operating pressure:		<input type="checkbox"/> Absolute pressure	<input type="checkbox"/> Gauge pressure
Rated pressure:			
Operating temperature:			
Rated temperature:			
Density:		<input type="checkbox"/> Standard density	<input type="checkbox"/> Operating density
Viscosity:			
Flow range:			
Comments:			

Contact data

Company:	
Contact person:	
Telephone number:	
Fax number:	
E-mail:	

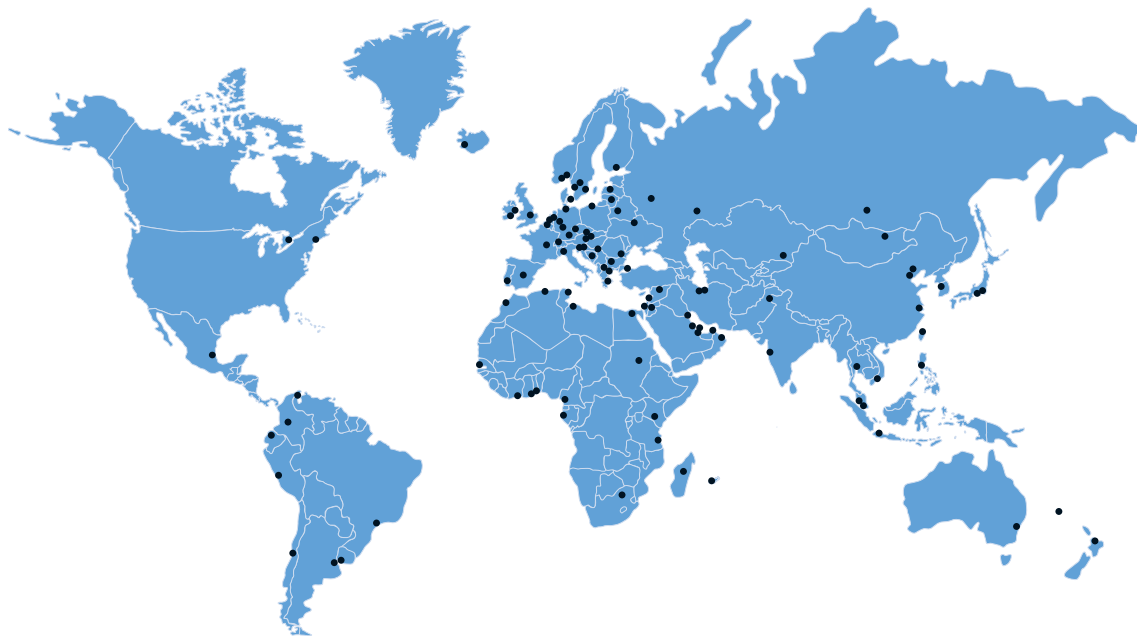

KROHNE – Process instrumentation and measurement solutions

- Flow
- Level
- Temperature
- Pressure
- Process Analysis
- Services

Head Office KROHNE Messtechnik GmbH
Ludwig-Krohne-Str. 5
47058 Duisburg (Germany)
Tel.: +49 203 301 0
Fax: +49 203 301 10389
info@krohne.com

The current list of all KROHNE contacts and addresses can be found at:
www.krohne.com

KROHNE