

SIL2/SIL3 Digital Out Loop/Bus Powered to drive Solenoid/LED/Horn DIN-Rail Models D1040Q, D1041Q, D1042Q, D1043Q

Characteristics:

General Description:

The D104* series are quad channel Din Rail Digital Output Modules enabling a Safe Area contact, logic level or drive signal, to control a device in Hazardous Area, providing 3 port isolation (input/output/supply).

Typical application includes driving signalling LED's, Visual or Audible Alarms to alert a plant operator or driving a Solenoid Valve or other process control devices. It can also be used as a controllable supply to power measuring or process control equipments in Hazardous Area.

Output channels can be paralleled if more power is required. 2 channels in parallel are still suitable for Gas Group II C. Four basic models meet a large number of applications: it is possible to obtain 16 different combinations of Safety Parameters and Driving Currents.

Function:

4 channels, actuated independently or in parallel to operate Hazardous Area Loads from contacts or logic levels or drive logics in Safe Area providing 3 port isolation (input/output/supply), Loop or Bus power.

Signalling LEDs:

Power supply indication (green), Output status (yellow).

Field Configurability:

Contact / logic levels inputs, Loop power operating mode, configurable by external wiring.

EMC:

Fully compliant with CE marking applicable requirements.

Front Panel and Features:

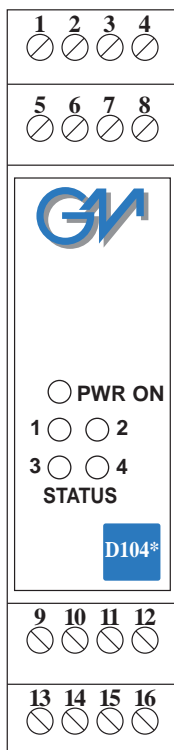

- SIL 2 according to IEC 61508, IEC 61511 when used in bus powered mode.
- SIL 3 according to IEC 61508, IEC 61511 when used in loop powered mode.
- Voltage input, common positive, common negative contacts, logic levels, loop powered or bus powered.
- Flexible modular multi output capability.
- Three port isolation, Input/Output/Supply.
- EMC Compatibility to EN61000-6-2, EN61000-6-4.
- Output short circuit proof and current limited.
- ATEX, UL & C-UL, Russia and Ukraine Certifications.
- High Reliability, SMD components.
- High Density, four channels per unit.
- Simplified installation using standard DIN Rail plug-in terminal blocks.
- 250 Vrms (Um) max. voltage applied to the instruments associated with barrier.

Technical Data:

Supply:

24 V nom (21.5 to 30 V) reverse polarity protected ripple within voltage limits ≤ 5 Vpp.

Current consumption @ 24 V: 130 mA four channels energized with nominal load, 150 mA with short circuit output (90 mA type D1041Q).

Max. power consumption: 4.30 W (2.6 W type D1041Q) with 30 V supply voltage and short circuit output.

Isolation (Test Voltage):

I.S. Out/In 1.5 KV; I.S. Out/Supply 1.5 KV; In/Supply 500 V.

Input:

Voltage free, common positive or common negative, contact, logic level, loop powered.

Trip voltage levels: OFF status ≤ 1.0 V, ON status ≥ 6.0 V.

Output:

D1040Q: 22 mA per channel at 13.2 V.

D1041Q: 10 mA per channel for LED driving.

D1042Q: 22 mA per channel at 14.5 V.

D1043Q: 22 mA per channel at 9.8 V.

Short circuit current: ≥ 24 mA per channel (26 mA typical) ≤ 15 mA for D1041Q (13 mA typical).

Response time: 20 ms.

Compatibility:

CE CE mark compliant, conforms to 94/9/EC Atex Directive and to 89/336/CEE EMC Directive.

Environmental conditions:

Operating: Temperature limits -20 to + 60 °C,

relative humidity max 90 % non condensing, up to 35 °C.

Storage: Temperature limits - 40 to + 80 °C.

Safety Description:

Ex II (1) G D [EEx ia] IIC or I M2 [EEx ia] I, II 3 G EEx nA IIC T4 associated electrical apparatus.

Uo/Voc = 23.6 V, Io/Isc, Po/Po see safety parameters table for different models and connections.

UL Um = 250 Vrms, -20 °C \leq Ta \leq 60°C.

Approvals: DMT 01 ATEX E 042 X conforms to EN50014, EN50020, UL & C-UL E222308 conforms to UL913 (Div.1), UL 60079-0 (General, All Zones), UL60079-11 (Intrinsic Safety "i" Zones 0 & 1), UL60079-15 ("n" Zone 2), UL 1604 (Div.2) for UL and CSA-C22.2 No.157-92 (Div.1), CSA-E60079-0 (General, All Zones), CSA-E60079-11 (Intrinsic Safety "i" Zones 0 & 1), CSA-C22.2 No. 213-M1987 (Div. 2) and CSA-E60079-15 ("n" Zone 2) for C-UL, TCCEXEE (Russia) Nr.665 according to GOST R 51330.0-99, 51330.10-99 [Exia]IIC X, TCCEXEE (Ukraine) Nr.665 according to GOST 12.2.007.0, 22782.0, 22782.5 ExiaIIC X, Gosgortekhnadzor of Russia Permit Nr. PPC 04-11284.

EXIDA Report No. GM04/10-26 R001, SIL 2 - SIL 3 according to IEC 61508, IEC 61511. Please refer to functional safety manual for SIL applications.

Mounting:

T35 DIN Rail according to EN50022.

Weight: about 130 g.

Connection: By polarized plug-in disconnect screw terminal blocks to accommodate terminations up to 2.5 mm².

Location: Safe Area/Non Hazardous Locations or Zone 2, Group IIC T4, Class I, Division 2, Groups A, B, C, D Temperature Code T4 and Class I, Zone 2, Group IIC, IIB, IIA T4 installation.

Protection class: IP 20.

Dimensions: Width 22.5 mm, Depth 99 mm, Height 114.5 mm.

Ordering Information:

Model:	D104*Q	
22 mA at 13.2 V (per channel)	0	
10 mA for LED driving (per channel)	1	
22 mA at 14.5 V (per channel)	2	
22 mA at 9.8 V (per channel)	3	
Power Bus enclosure		/B



D1040Q Parameters Table Single-Dual Output:

Safety Description	Maximum External Parameters			
	Group Cenelec	Co/Ca (μF)	Lo/La (mH)	Lo/Ro (μH/Ω)
Terminals 13-14, 15-16 9-10, 11-12	(Quad channel: 1 + 1 + 1 + 1)			
Uo/Voc = 23.6 V	II C	0.130	6.40	83.9
Io/Isc = 72.0 mA	II B	0.970	25.90	335.9
Po/Po = 424 mW	II A	3.500	51.80	671.9
Terminals 13/15-14/16 9/11-10/12	(Dual channel: 2 parallel + 2 parallel)			
Uo/Voc = 23.6 V	II C	0.130	1.61	41.9
Io/Isc = 144.0 mA	II B	0.970	6.40	167.9
Po/Po = 848 mW	II A	3.500	12.90	335.9

D1040Q Parameters Table Triple-Quad Output:

Safety Description	Maximum External Parameters			
	Group Cenelec	Co/Ca (μF)	Lo/La (mH)	Lo/Ro (μH/Ω)
Terminals 13/15/9-14/16/10	(Dual channel: 3 parallel + 1)			
Uo/Voc = 23.6 V				
Io/Isc = 216.0 mA	II B	0.970	2.80	111.9
Po/Po = 1272 mW	II A	3.500	5.70	223.9
Terminals 13/15/9/11-14/16/10/12	(Single channel: 4 parallel)			
Uo/Voc = 23.6 V				
Io/Isc = 288.0 mA	II B	0.970	1.61	83.9
Po/Po = 1674 mW	II A	3.500	3.20	167.9

D1042Q Parameters Table Single-Dual Output:

Safety Description	Maximum External Parameters			
	Group Cenelec	Co/Ca (μF)	Lo/La (mH)	Lo/Ro (μH/Ω)
Terminals 13-14, 15-16 9-10, 11-12	(Quad channel: 1 + 1 + 1 + 1)			
Uo/Voc = 23.6 V	II C	0.130	4.30	68.6
Io/Isc = 88.2 mA	II B	0.970	17.20	274.4
Po/Po = 519 mW	II A	3.500	34.50	548.9
Terminals 13/15-14/16 9/11-10/12	(Dual channel: 2 parallel + 2 parallel)			
Uo/Voc = 23.6 V				
Io/Isc = 176.4 mA	II B	0.970	4.32	137.2
Po/Po = 1038 mW	II A	3.500	8.64	274.4

D1042Q Parameters Table Triple-Quad Output:

Safety Description	Maximum External Parameters			
	Group Cenelec	Co/Ca (μF)	Lo/La (mH)	Lo/Ro (μH/Ω)
Terminals 13/15/9-14/16/10	(Dual channel: 3 parallel + 1)			
Uo/Voc = 23.6 V				
Io/Isc = 264.6 mA	II B	0.970	1.92	91.4
Po/Po = 1557 mW	II A	3.500	3.84	182.9
Terminals 13/15/9/11-14/16/10/12	(Single channel: 4 parallel)			
Uo/Voc = 23.6 V				
Io/Isc = 352.8 mA	II B	0.970	1.08	68.6
Po/Po = 1674 mW	II A	3.500	2.16	137.2

D1041Q, D1043Q Parameters Table Single-Dual Output:

Safety Description	Maximum External Parameters			
	Group Cenelec	Co/Ca (μF)	Lo/La (mH)	Lo/Ro (μH/Ω)
Terminals 13-14, 15-16 9-10, 11-12	(Quad channel: 1 + 1 + 1 + 1)			
Uo/Voc = 23.6 V	II C	0.130	12.00	121.0
Io/Isc = 49.6 mA	II B	0.970	48.00	487.0
Po/Po = 292 mW	II A	3.500	96.10	975.0
Terminals 13/15-14/16 9/11-10/12	(Dual channel: 2 parallel + 2 parallel)			
Uo/Voc = 23.6 V	II C	0.130	3.00	60.9
Io/Isc = 99.2 mA	II B	0.970	12.00	243.8
Po/Po = 584 mW	II A	3.500	24.00	487.6

D1041Q, D1043Q Parameters Table Triple-Quad Output:

Safety Description	Maximum External Parameters			
	Group Cenelec	Co/Ca (μF)	Lo/La (mH)	Lo/Ro (μH/Ω)
Terminals 13/15/9-14/16/10	(Dual channel: 3 parallel + 1)			
Uo/Voc = 23.6 V	II C	0.130	1.33	40.6
Io/Isc = 148.8 mA	II B	0.970	5.33	162.5
Po/Po = 876 mW	II A	3.500	10.60	325.1
Terminals 13/15/9/11-14/16/10/12	(Single channel: 4 parallel)			
Uo/Voc = 23.6 V				
Io/Isc = 198.4 mA	II B	0.970	3.00	121.9
Po/Po = 1168 mW	II A	3.500	6.00	243.8

NOTE for USA and Canada:

II C equal to Gas Groups A, B, C, D, E, F and G. - II B equal to Gas Groups C, D, E, F and G. - II A equal to Gas Groups D, E, F and G.

Function Diagram:

HAZARDOUS AREA / HAZARDOUS LOCATIONS
 CLASS I, DIVISION 1, GROUPS A, B, C, D and
 CLASS II, DIVISION 1, GROUPS E, F, G or CLASS I, Zone 0, GROUP IIC

SAFE AREA / NON HAZARDOUS LOCATIONS or
 ZONE 2, GROUP IIC T4, CLASS I, DIVISION 2, GROUPS A, B, C, D T-Code T4,
 CLASS I, ZONE 2, GROUP IIC T4

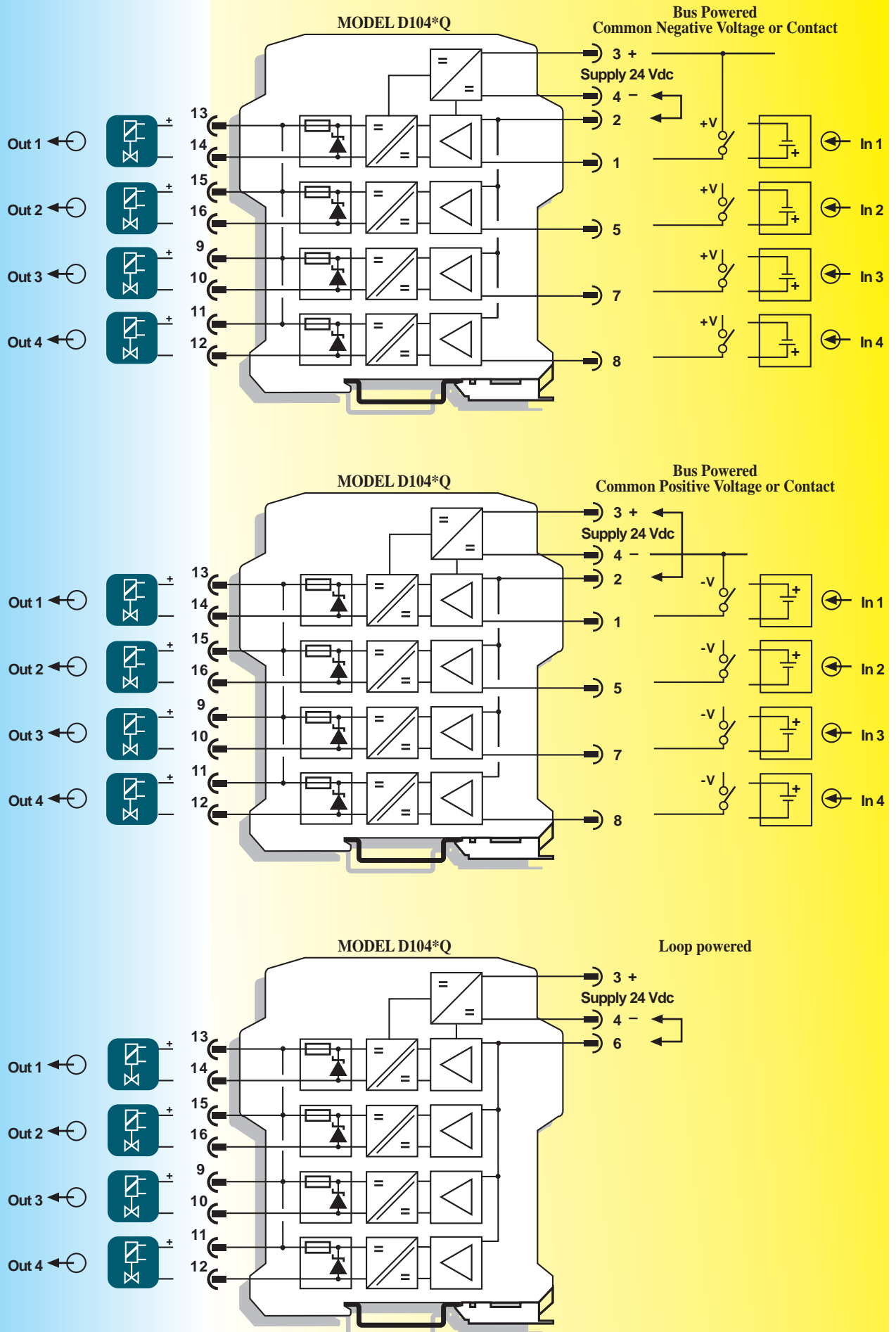

Function Diagram:

HAZARDOUS AREA / HAZARDOUS LOCATIONS
 CLASS I, DIVISION 1, GROUPS A, B, C, D and
 CLASS II, DIVISION 1, GROUPS E, F, G or CLASS I, Zone 0, GROUP IIC

SAFE AREA / NON HAZARDOUS LOCATIONS or
 ZONE 2, GROUP IIC T4, CLASS I, DIVISION 2, GROUPS A, B, C, D T-Code T4,
 CLASS I, ZONE 2, GROUP IIC T4

MODEL D104*Q

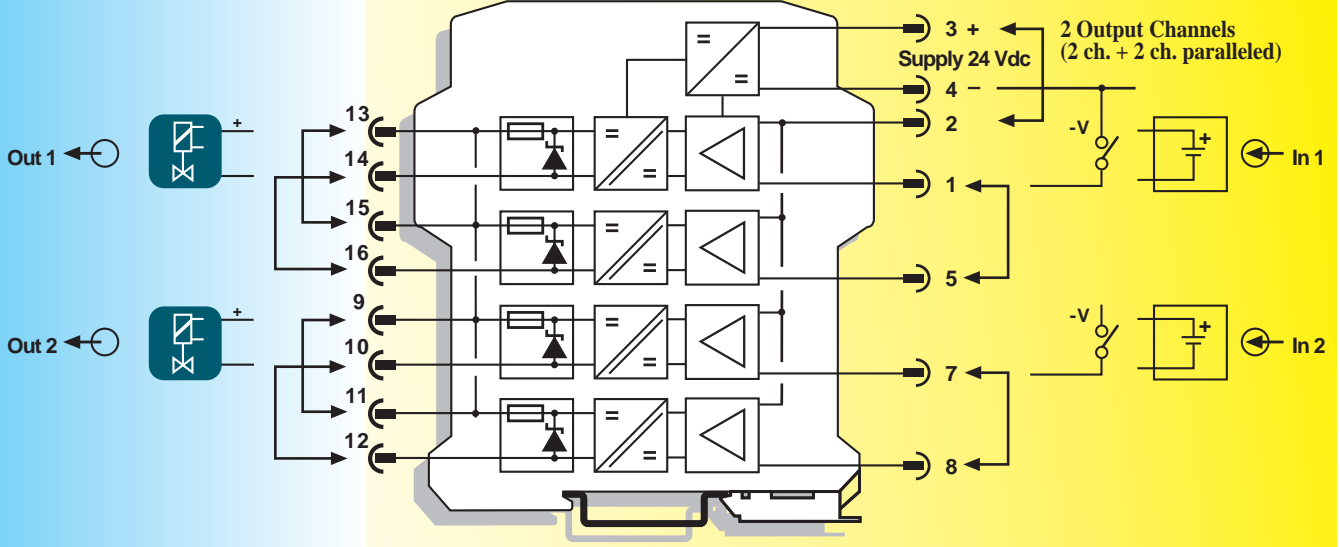

NOTE: Common Negative Input Connection can also be used

MODEL D104*Q

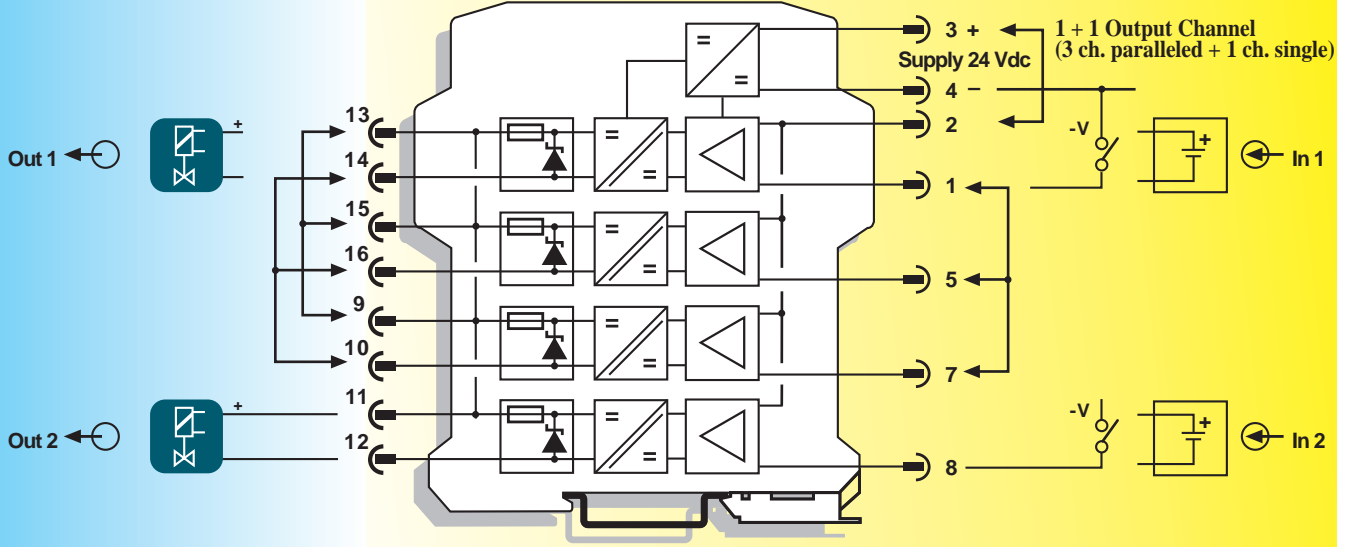

NOTE: Common Negative Input Connection can also be used

MODEL D104*Q

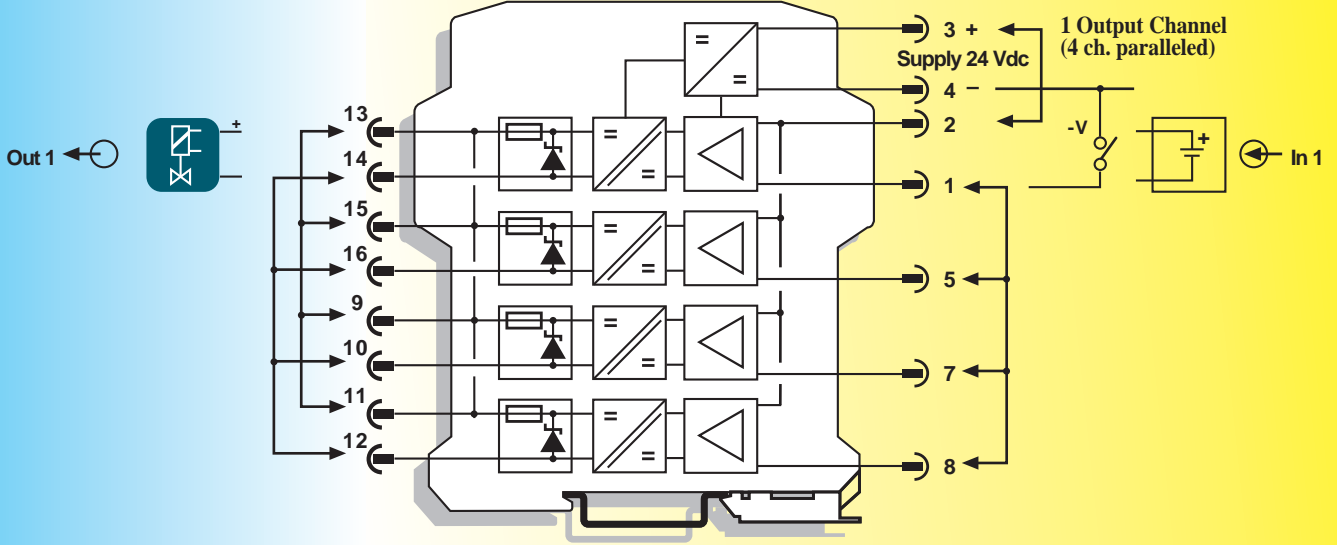

NOTE: Common Negative Input Connection can also be used

D1040Q - D1041Q OUTPUT DIAGRAM

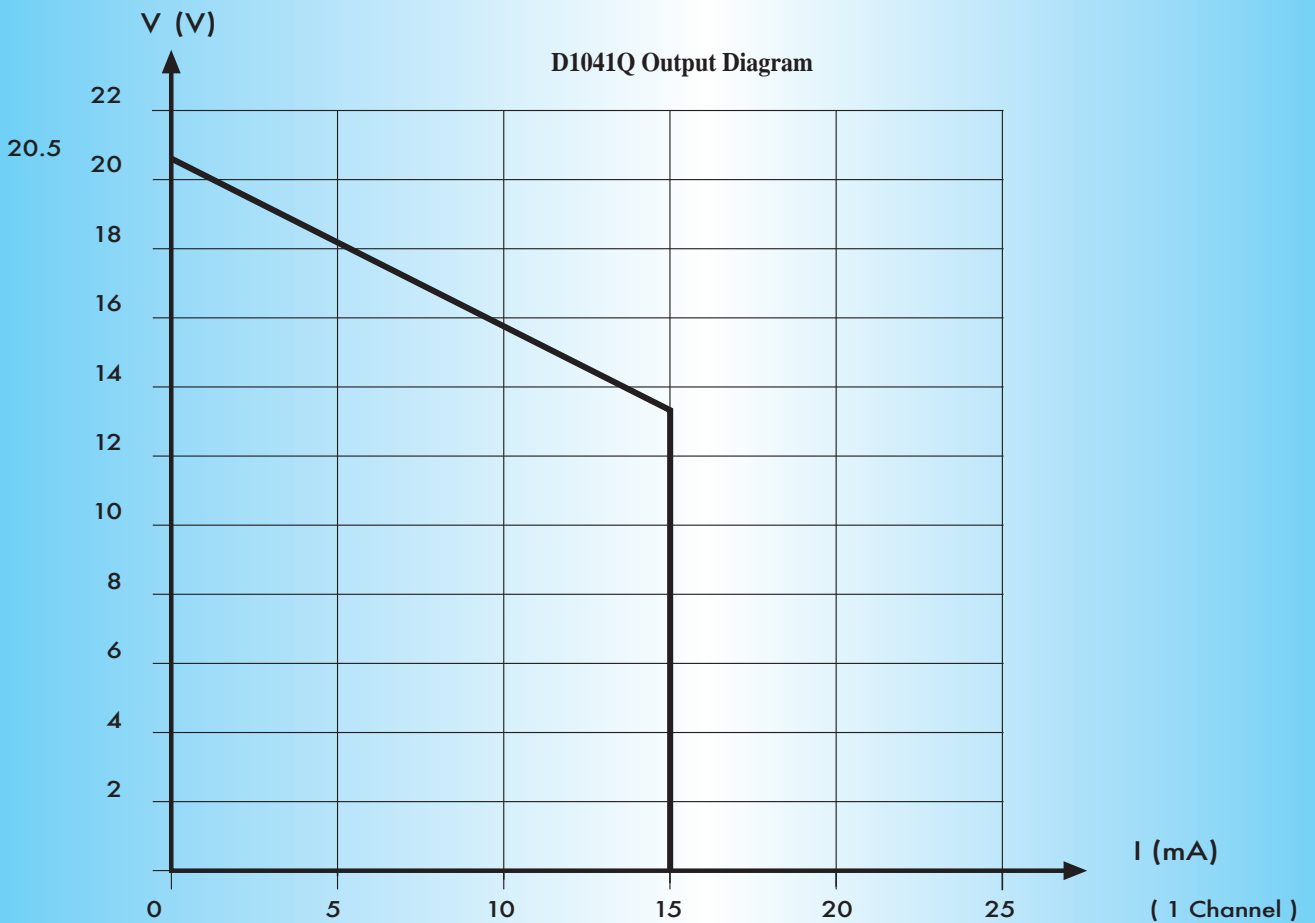
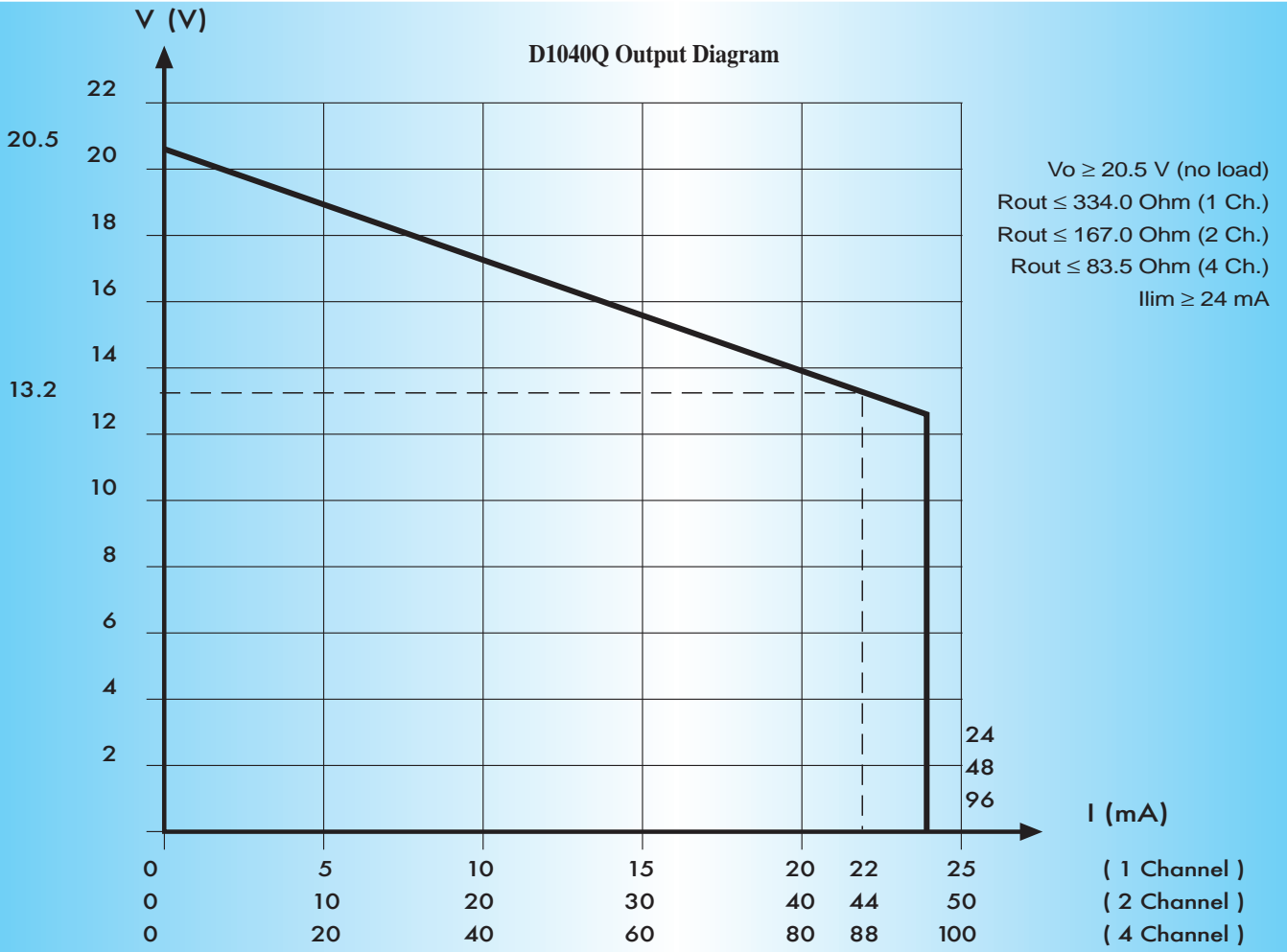

D1042Q - D1043Q OUTPUT DIAGRAM

D1042Q Output Diagram

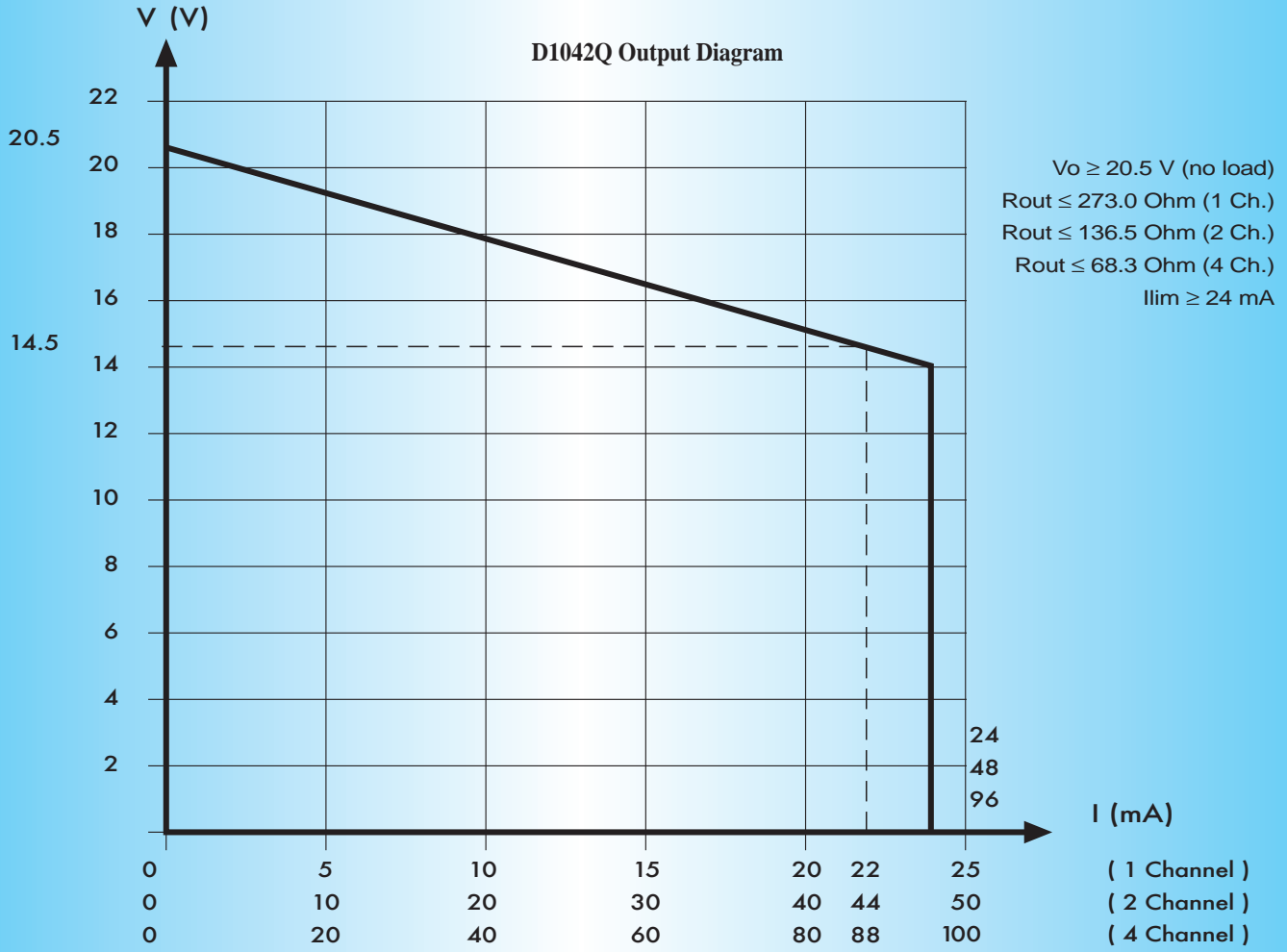

D1043Q Output Diagram

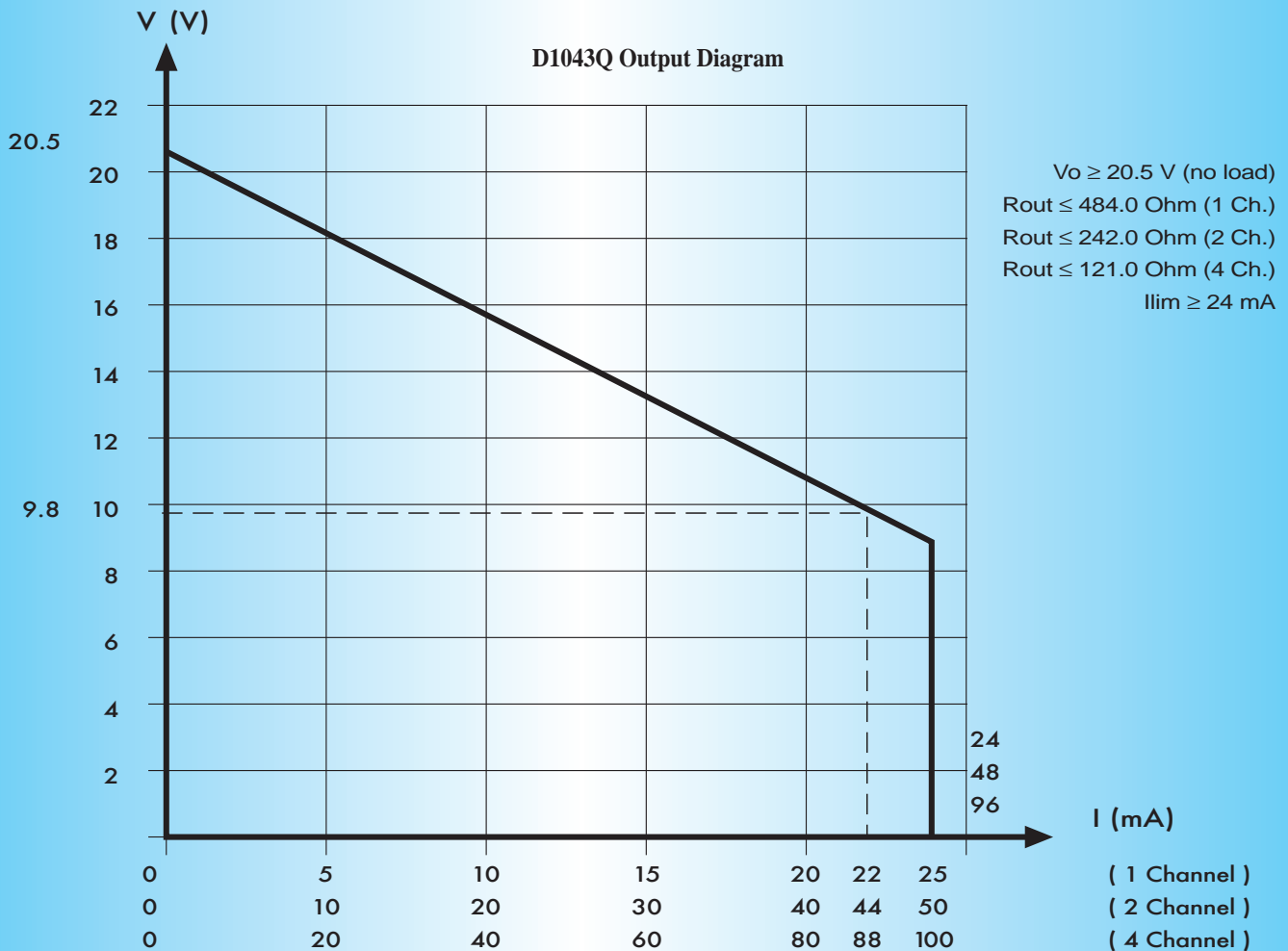

Models Selection Using the PC Software Available on Web Site

G.M. International presents a software for “quick DIN Rail Isolator Selection” of all D1000 Series available Models. The software is downloadable at www.gminternationalsrl.com

Specifically for Digital Output: inserting the solenoid I.S. parameters, available from the certificate, and the coil parameters available from the Data Sheet of the Unit, the software automatically selects the right Isolator Model. It is also possible to display all the available models.

Coil Max. Open Voltage V (Ui)
from the I.S. Certificate.

Coil Resistance at ambient Temperature Ω.

Coil Max. Short Circuit Current mA (Ii)
from the I.S. Certificate.

Cable Resistance Ω.

Coil Max. Power mW (Po)
allowed by the I.S. Certificate.

Coil Minimum Exciting Current mA.

G.M. International srl - DIN Rail Isolator Selection [v. 1.5]

mV - Temperature Converters | Frequency / Potentiometer / Load cells / Serial Lines | Start

Analog In/Out | Digital Input | Digital Output | Analog Signal Converters

Digital Output

from Solenoid I.S. Certificate | from Solenoid Data Sheet

Ui: [] [V] | Coil Resistance: [] [Ohm]

Ii: [] [mA] | Cable Resistance: [] [Ohm]

Pi: [] [mW] | Min. Exciting Current: [] [mA]

Display all available models | Display models that suite this application

Model	Gas Group	Description	Max Power	Max Current	Resistance
D1040Q	IIC IIB IIA	4 separate channels	499 mW	74,1 mA	334 Ohm
D1040Q	IIC IIB IIC	2 + 2 channels in parallel	898 mW	148,2 mA	167 Ohm
D1040Q	IIB IIA	3 channels in parallel	1347 mW	222,3 mA	111 Ohm
D1040Q	IIB IIA	4 channels in parallel	1796 mW	296,4 mA	84 Ohm
D1040Q	IIB IIA	5 channels in parallel (2 units)	2242 mW	370,5 mA	67 Ohm
D1040Q	IIA	7 channels in parallel (2 units)	3139 mW	518,7 mA	48 Ohm
D1042Q	IIC IIB IIA	4 separate channels	563 mW	93 mA	273 Ohm
D1042Q	IIB IIA	2 + 2 channels in parallel	1126 mW	186 mA	137 Ohm
D1042Q	IIB IIA	3 channels in parallel	1689 mW	279 mA	91 Ohm
D1042Q	IIB IIA	4 channels in parallel	2252 mW	372 mA	68 Ohm
D1042Q	IIB IIA	6 channels in parallel (2 units)	3376 mW	558 mA	46 Ohm
D1043Q	IIC IIB IIA	4 separate channels	333 mW	55 mA	455 Ohm
D1043Q	IIC IIB IIA	2 + 2 channels in parallel	666 mW	110 mA	227 Ohm
D1043Q	IIC IIB IIA	3 channels in parallel	999 mW	165 mA	152 Ohm
D1043Q	IIB IIA	4 channels in parallel	1332 mW	220 mA	114 Ohm
D1043Q	IIB IIA	7 channels in parallel (2 units)	2330 mW	385 mA	65 Ohm
D1043Q	IIA	10 channels in parallel (3 units)	3328 mW	550 mA	46 Ohm

	Model	Gas Group	Description	Max Power mW (Po)	Max Current mA (Io)	Barrier Resistance Ω	Supply	SIL Level
Solenoid Driver	D1040Q	IIC IIB IIA	4 separate channels	424 mW	72.0 mA	334 Ω	Bus 20-30 V	2
	D1040Q	IIC IIB IIA	2 + 2 channels in parallel	848 mW	144.0 mA	167 Ω	Bus 20-30 V	2
	D1040Q	IIB IIA	3 channels in parallel	1272 mW	216.0 mA	112 Ω	Bus 20-30 V	2
	D1040Q	IIB IIA	4 channels in parallel	1674 mW	288.0 mA	84 Ω	Bus 20-30 V	2
	D1040Q	IIB IIA	5 channels in parallel (2 units)	2120 mW	360.0 mA	67 Ω	Bus 20-30 V	2
	D1040Q	IIA	7 channels in parallel (2 units)	2946 mW	504.0 mA	48 Ω	Bus 20-30 V	2
	D1040Q	IIC IIB IIA	1 channel	424 mW	72.0 mA	334 Ω	Loop Powered	3
	D1040Q	IIC IIB IIA	2 channels in parallel	848 mW	144.0 mA	167 Ω	Loop Powered	3
	D1040Q	IIB IIA	3 channels in parallel	1272 mW	216.0 mA	112 Ω	Loop Powered	3
	D1040Q	IIB IIA	4 channels in parallel	1674 mW	288.0 mA	84 Ω	Loop Powered	3
	D1040Q	IIB IIA	5 channels in parallel (2 units)	2120 mW	360.0 mA	67 Ω	Loop Powered	3
	D1040Q	IIA	7 channels in parallel (2 units)	2946 mW	504.0 mA	48 Ω	Loop Powered	3
LED Driver	D1041Q	IIC IIB IIA	4 separate channels	292 mW	49.6 mA	484 Ω	Bus 20-30 V	2
	D1041Q	IIC IIB IIA	1 channel	292 mW	49.6 mA	484 Ω	Loop Powered	3
Solenoid Driver	D1042Q	IIC IIB IIA	4 separate channels	519 mW	88.2 mA	273 Ω	Bus 20-30 V	2
	D1042Q	IIB IIA	2 + 2 channels in parallel	1038 mW	176.4 mA	137 Ω	Bus 20-30 V	2
	D1042Q	IIB IIA	3 channels in parallel	1557 mW	264.6 mA	91 Ω	Bus 20-30 V	2
	D1042Q	IIB IIA	4 channels in parallel	1674 mW	352.8 mA	69 Ω	Bus 20-30 V	2
	D1042Q	IIB IIA	6 channels in parallel (2 units)	3114 mW	529.2 mA	46 Ω	Bus 20-30 V	2
	D1042Q	IIC IIB IIA	1 channel	519 mW	88.2 mA	273 Ω	Loop Powered	3
	D1042Q	IIB IIA	2 channels in parallel	1038 mW	176.4 mA	137 Ω	Loop Powered	3
	D1042Q	IIB IIA	3 channels in parallel	1557 mW	264.6 mA	91 Ω	Loop Powered	3
	D1042Q	IIB IIA	4 channels in parallel	1674 mW	352.8 mA	69 Ω	Loop Powered	3
	D1042Q	IIB IIA	6 channels in parallel (2 units)	3114 mW	529.2 mA	46 Ω	Loop Powered	3
Solenoid Driver	D1043Q	IIC IIB IIA	4 separate channels	292 mW	49.6 mA	484 Ω	Bus 20-30 V	2
	D1043Q	IIC IIB IIA	2 + 2 channels in parallel	584 mW	99.2 mA	242 Ω	Bus 20-30 V	2
	D1043Q	IIC IIB IIA	3 channels in parallel	876 mW	148.8 mA	162 Ω	Bus 20-30 V	2
	D1043Q	IIB IIA	4 channels in parallel	1168 mW	198.4 mA	121 Ω	Bus 20-30 V	2
	D1043Q	IIB IIA	7 channels in parallel (2 units)	2044 mW	347.2 mA	70 Ω	Bus 20-30 V	2
	D1043Q	IIA	10 channels in parallel (3 units)	2920 mW	496.0 mA	49 Ω	Bus 20-30 V	2
	D1043Q	IIC IIB IIA	1 channel	292 mW	49.6 mA	484 Ω	Loop Powered	3
	D1043Q	IIC IIB IIA	2 channels in parallel	584 mW	99.2 mA	242 Ω	Loop Powered	3
	D1043Q	IIC IIB IIA	3 channels in parallel	876 mW	148.8 mA	162 Ω	Loop Powered	3
	D1043Q	IIB IIA	4 channels in parallel	1168 mW	198.4 mA	121 Ω	Loop Powered	3
	D1043Q	IIB IIA	7 channels in parallel (2 units)	2044 mW	347.2 mA	70 Ω	Loop Powered	3
	D1043Q	IIA	10 channels in parallel (3 units)	2920 mW	496.0 mA	49 Ω	Loop Powered	3

NOTE: if two units are used on the same solenoid, the application is suitable only for Zone 1.